

All rights reserved, Copyright Kradox 2016		
Product model	Enclosure Z117S - assembly	
Format: A3	Material: PS, ABS	
Scale 1:1	Tolerance: +/- 0.2	

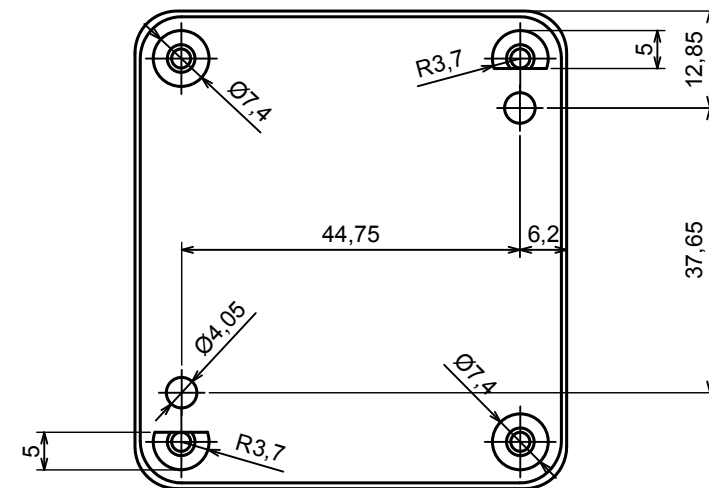
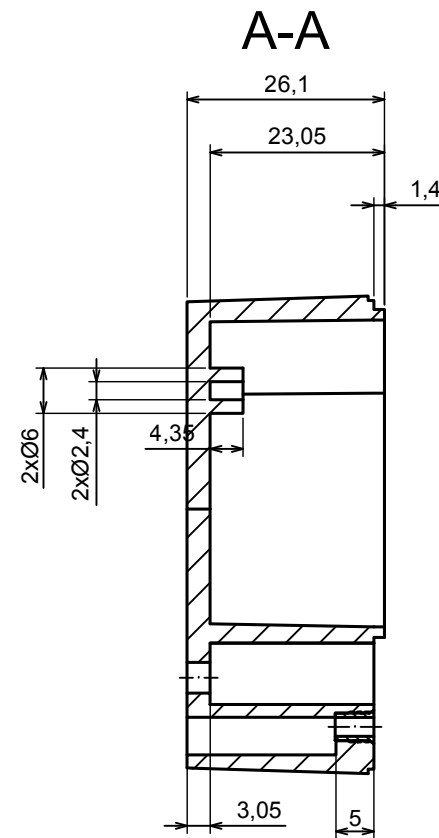
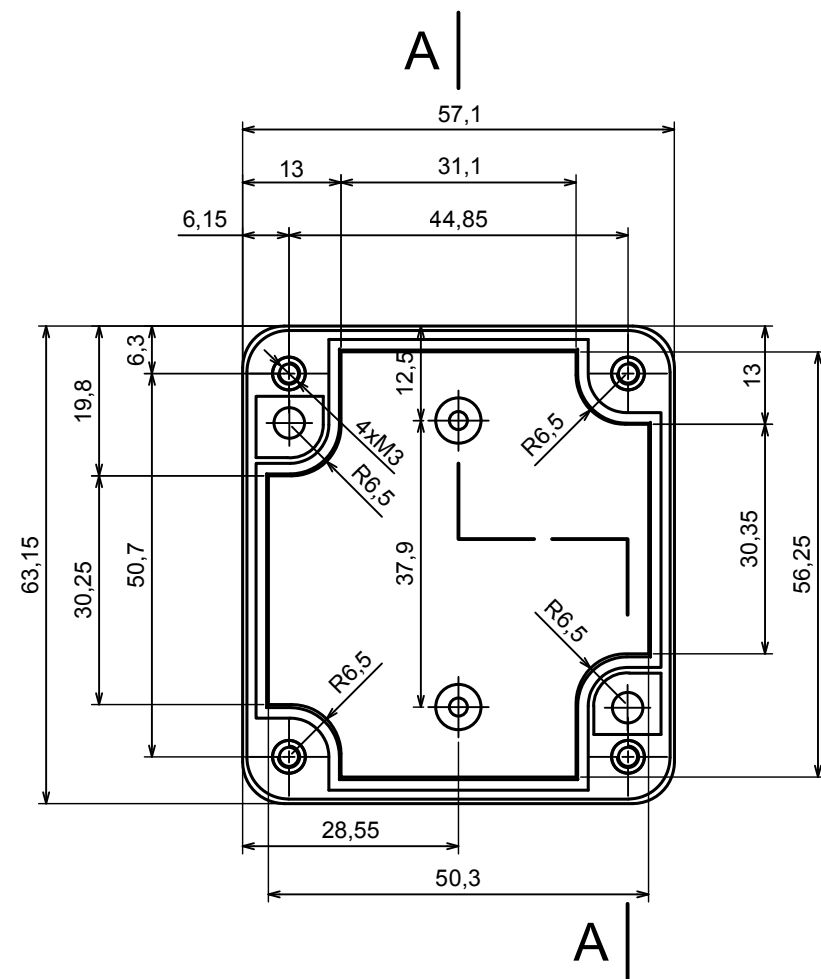

All rights reserved, Copyright Kradox 2016

Product model Enclosure Z117S - base

Format: A3 Material: PS, ABS

Scale 1:1 Tolerance: +/- 0.2



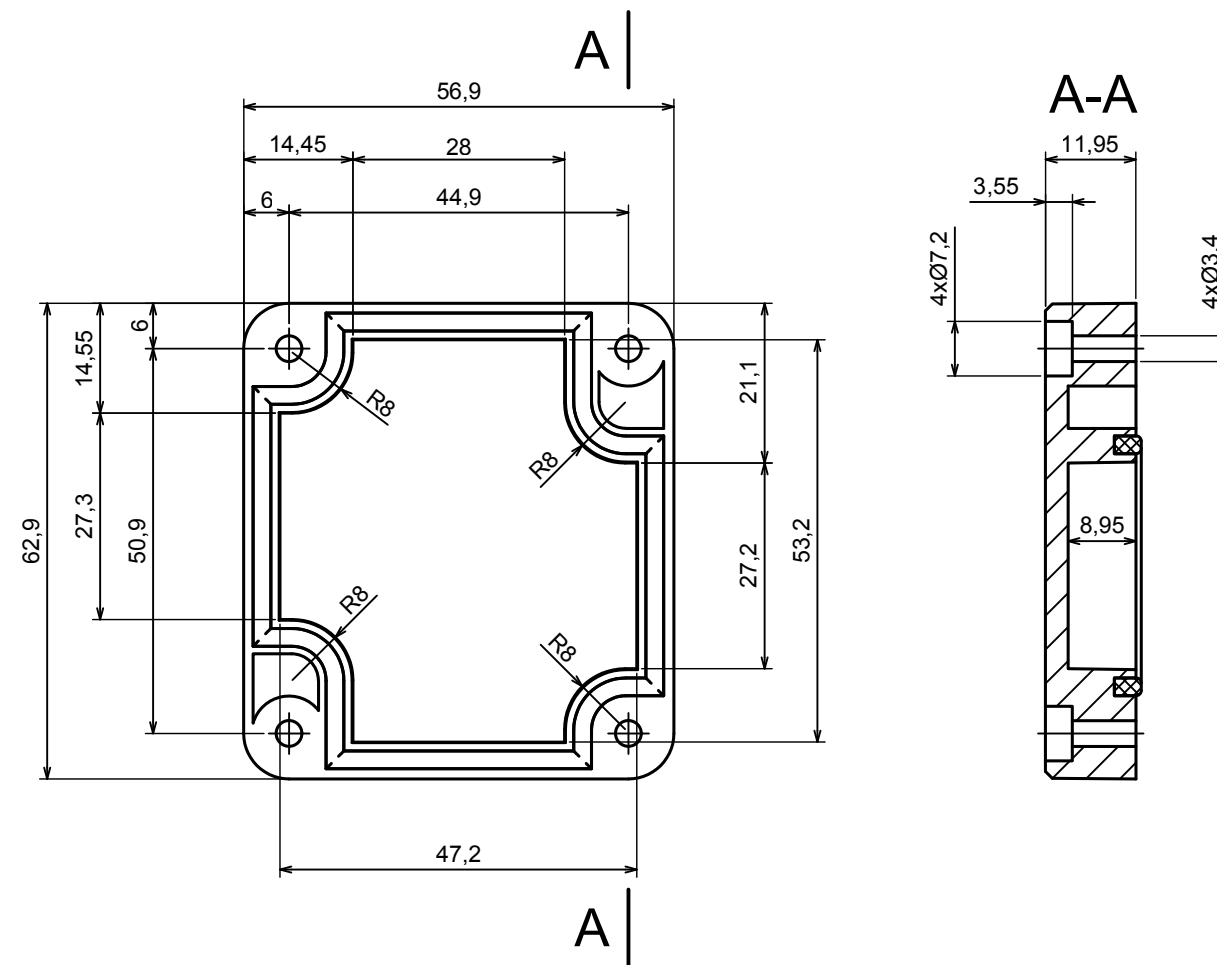

All rights reserved, Copyright Kradex 2016

Product model: Enclosure Z117S - cover

Format: A3 Material: PS, ABS

Scale 1:1 Tolerance: +/- 0.2

