

All rights reserved, Copyright Kradox 2017

Product model	Enclosure Z112B - Assembly
---------------	----------------------------

Format: A3	Material: PS, ABS
------------	-------------------

Scale 1:2	Tolerance: +/- 0.6
-----------	--------------------



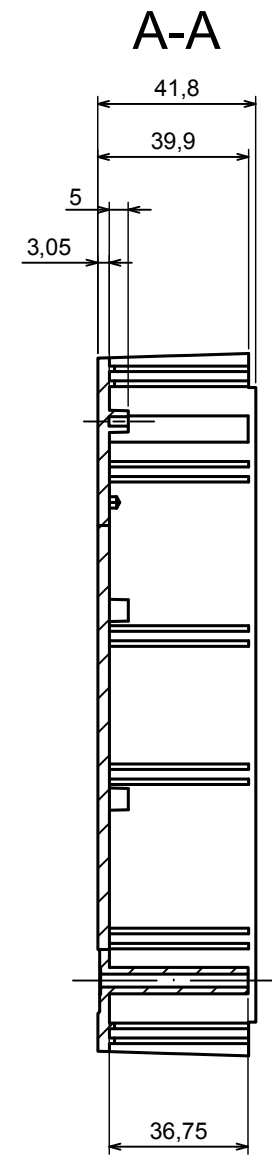
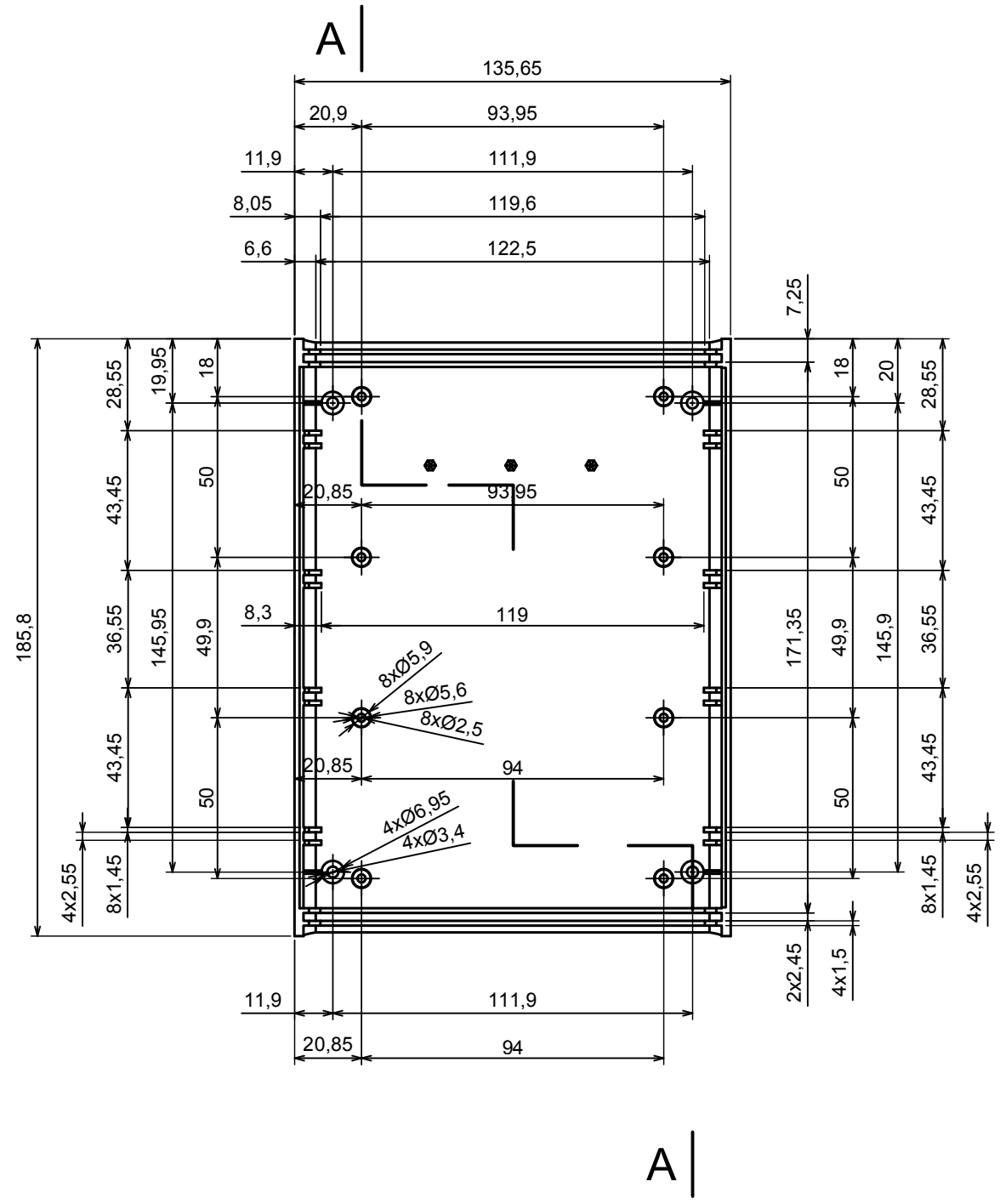

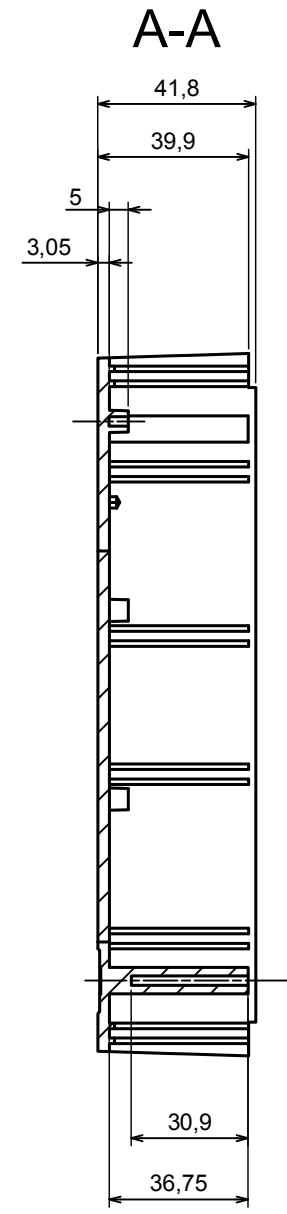
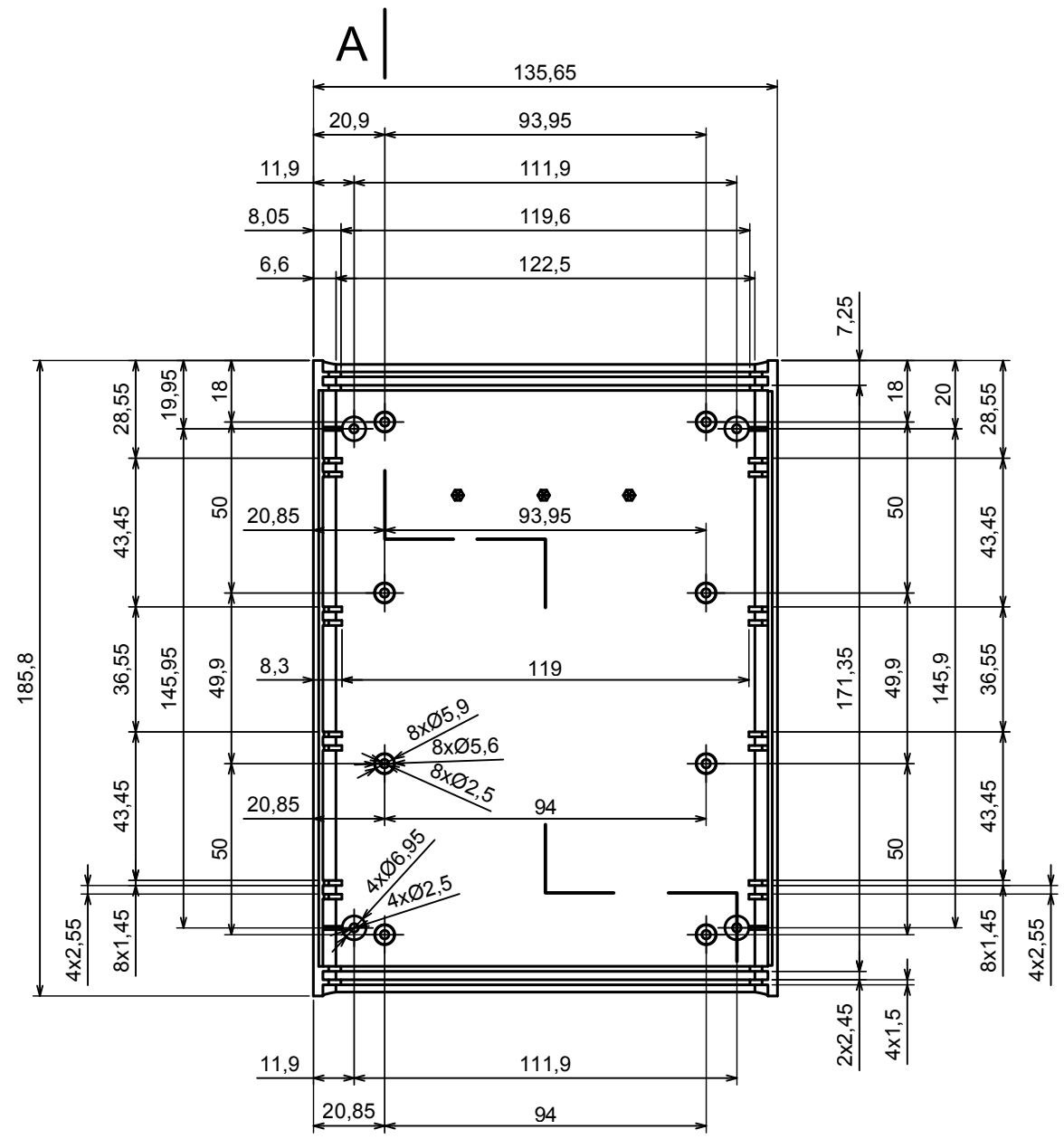

All rights reserved, Copyright Kradox 2017		
Product model	Enclosure Z112B - Base	
Format: A3	Material: PS, ABS	
Scale 1:2	Tolerance: +/- 0.6	

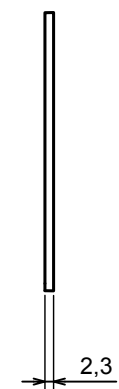
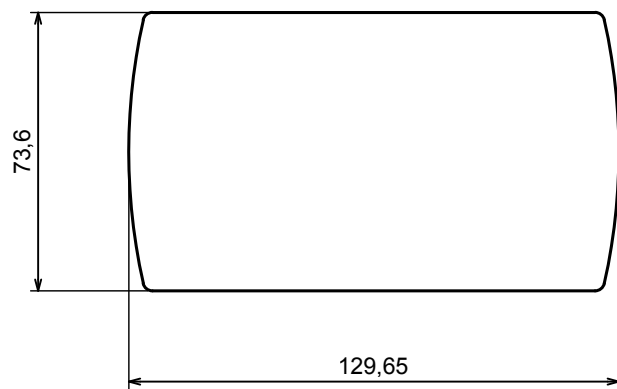

A |

All rights reserved, Copyright Kradox 2017		
Product model	Enclosure Z112B - Cover	
Format: A3	Material: PS, ABS	
Scale 1:2	Tolerance: +/- 0.6	



All rights reserved, Copyright Kradex 2017		
Product model	Enclosure Z112B - Board	
Format: A3	Material: PS, ABS	
Scale 1:2	Tolerance: +/- 0.6	

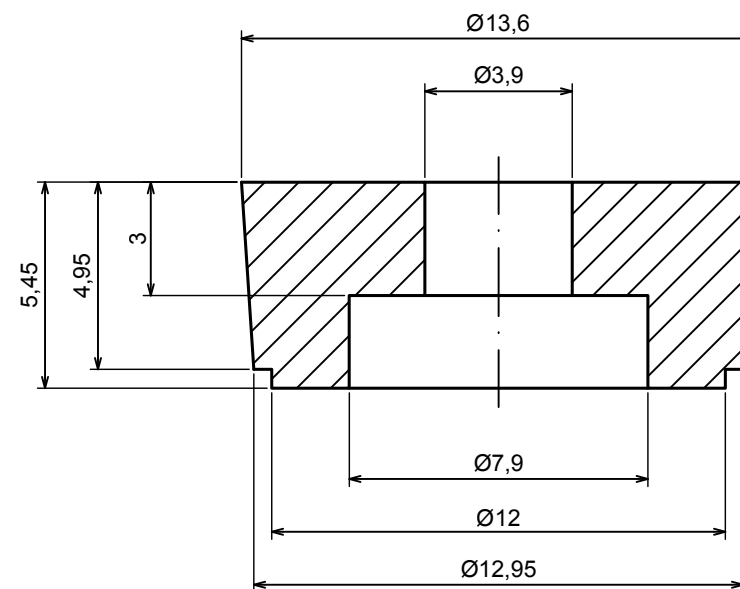

All rights reserved, Copyright Kradox 2017

Product model: Enclosure Z112B - Foot

Format: A3 Material: PS, ABS

Scale 5:1 Tolerance: +/- 0.5

