

A |

All rights reserved, Copyright Kradex 2020

Product model Enclosure ZP150.100.60SU TM - Assembly

Format: A3 Material: PC, ABS

Scale 1:2 Tolerance: +/- 0.5



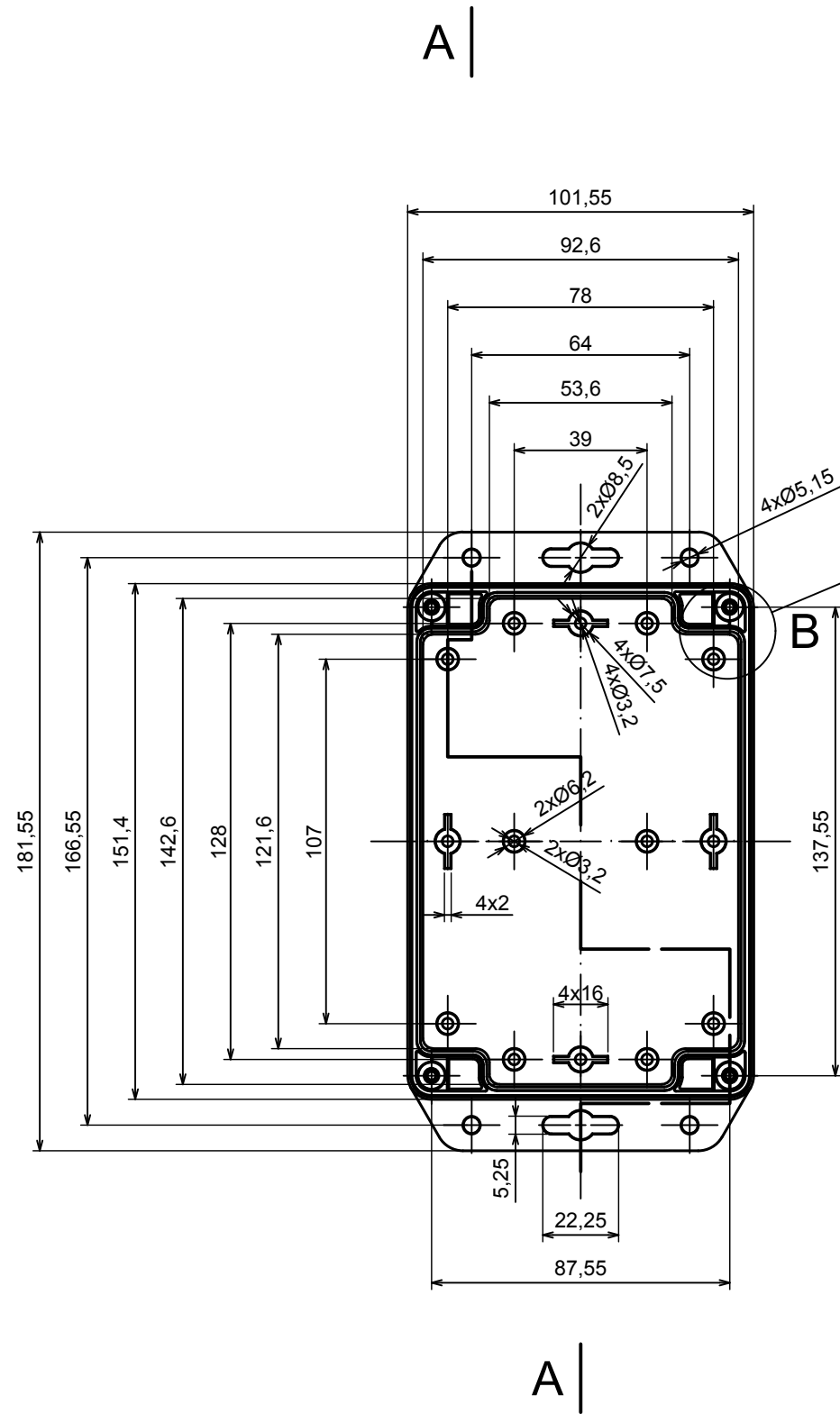

B (1:1)

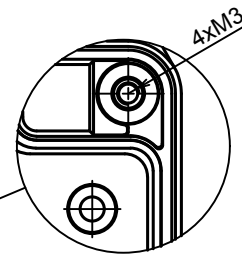

A-A

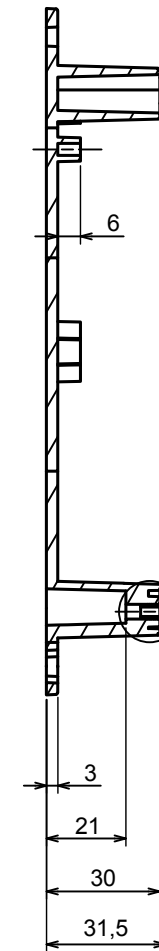

C (1:1)

C

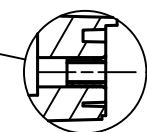

All rights reserved, Copyright Kradox 2020

Product model: Enclosure ZP150.100.60SU TM - Base ZP150.100.30U TM

Format: A3 Material: PC, ABS

Scale 1:2 Tolerance: +/- 0.5



A |

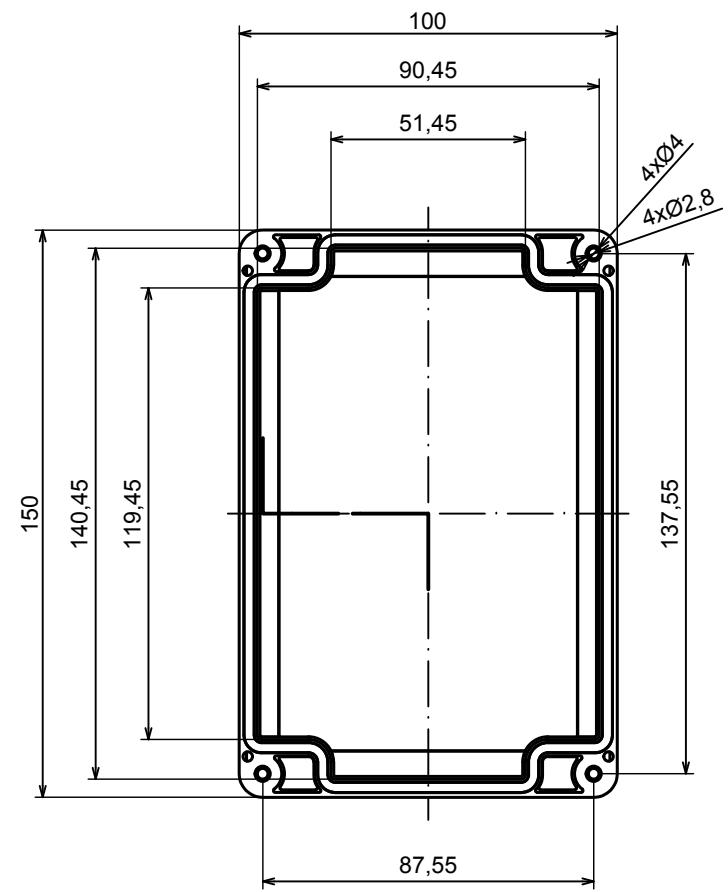

A |

A-A

B (1:1)

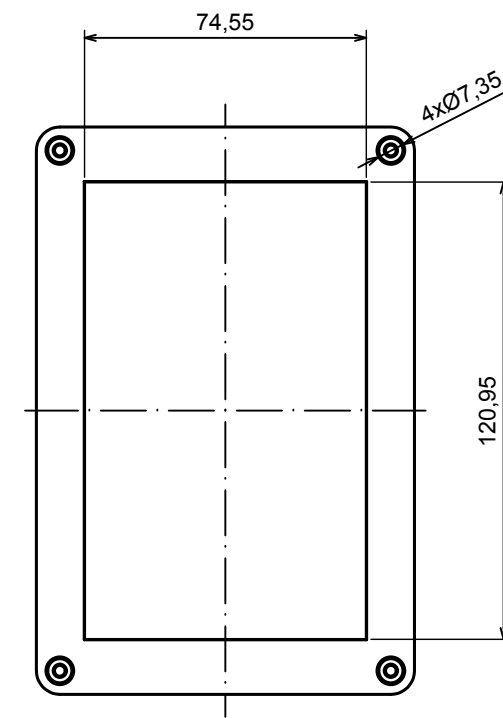
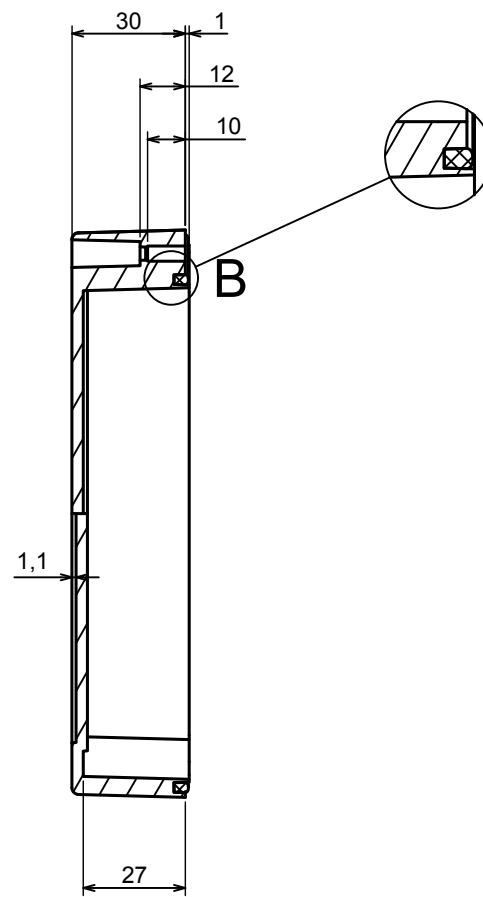

All rights reserved, Copyright Kradox 2020

Product model Enclosure ZP150.100.60SU TM - Cover ZP150.100.30S

Format: A3 Material: PC, ABS

Scale 1:2 Tolerance: +/- 0.5

